

Acer beTouch E110

User Guide

© 2010 All Rights Reserved

Acer beTouch E110 Smartphone User Guide

First issue: 07/2010

Acer beTouch E110 Smartphone

Model number: _____

Serial number: _____

Date of purchase: _____

Place of purchase: _____

End User Licence Agreement

IMPORTANT-READ CAREFULLY: THIS END USER LICENSE AGREEMENT ("AGREEMENT") IS A LEGAL AGREEMENT BETWEEN YOU (EITHER AN INDIVIDUAL OR A SINGLE ENTITY), AND ACER INC. INCLUDING ITS SUBSIDIARIES ("ACER") FOR THE SOFTWARE (WHETHER PROVIDED BY ACER OR BY ACER'S LICENSORS OR SUPPLIERS) THAT ACCOMPANIES THIS AGREEMENT, INCLUDING ANY ASSOCIATED MEDIA, PRINTED MATERIALS AND RELATED USER ELECTRONIC DOCUMENTATION WHICH MAY BE BRANDED "ACER" ("SOFTWARE"). AGREEMENTS RELATING TO ANY OTHER PRODUCT OR TOPIC ARE NEITHER INTENDED NOR SHOULD THEY BE IMPLIED. BY INSTALLING THE ACCOMPANYING SOFTWARE OR ANY PORTION THEREOF, YOU AGREE TO BE BOUND BY THE TERMS AND CONDITIONS OF THIS AGREEMENT. IF YOU DO NOT AGREE TO ALL OF THE TERMS AND CONDITIONS OF THIS AGREEMENT, DO NOT CONTINUE THE INSTALLATION PROCESS AND IMMEDIATELY DELETE ALL INSTALLED FILES, IF ANY, OF THE ACCOMPANYING SOFTWARE FROM YOUR PHONE.

IF YOU DO NOT HAVE A VALIDLY-LICENSED COPY OF THE APPLICABLE SOFTWARE, YOU ARE NOT AUTHORIZED TO INSTALL, COPY OR OTHERWISE USE THE SOFTWARE, AND HAVE NO RIGHTS UNDER THIS AGREEMENT.

The Software is protected by U.S. and international copyright laws and conventions as well as other intellectual property laws and treaties. The Software is licensed, not sold.

GRANT OF LICENSE

Acer grants to you the following non-exclusive and non-transferable rights with respect to the Software. Under this Agreement, you may:

1. Install and use the Software only on a single designated phone. A separate license is required for each phone on which the Software will be used;
2. Make one copy of the Software solely for backup or archival purposes;
3. Make one hardcopy of any electronic documents included in the Software, provided that you receive the documents electronically.

RESTRICTIONS

You may NOT:

1. Use or copy the Software except as provided in this Agreement;
2. Rent or lease the Software to any third party;
3. Modify, adapt, or translate the Software in whole or in part;
4. Reverse engineer, decompile, or disassemble the Software or create derivative works based upon the Software;
5. Merge the Software with any other program or modify the Software, except for your personal use; and
6. Sublicense or otherwise make the Software available to third parties, except that you may, after prior written notification to Acer, transfer the Software as a whole to a third party so long as you do not retain any copies of the Software and such third party accepts the terms of this Agreement.
7. Transfer your rights under this Agreement to any third parties.

8. Export the Software in contravention of applicable export laws and regulations, or (i) sell, export, re-export, transfer, divert, disclose technical data, or dispose of, any Software to any prohibited person, entity, or destination including, without limitation, Cuba, Iran, North Korea, Sudan and Syria; or (ii) use any Software for any use prohibited by the laws or regulations of the United States.

SUPPORT SERVICES

Acer is not obligated to provide technical or other support for the Software.

ACER LIVE UPDATE

Certain of the software contains elements that enable the use of the Acer Live Update service, which allows for updates for such software to be automatically downloaded and installed on your phone. By installing the software, you hereby agree and consent that Acer (or its licensors) may automatically check the version of such software that you are using on your phone and may provide upgrades to such software that may be automatically downloaded on to your phone.

OWNERSHIP AND COPYRIGHT

Title, ownership rights and intellectual property rights in and to the Software and all copies thereof shall remain with Acer or Acer's licensors or suppliers (as applicable). You do not have or shall not gain any proprietary interest in the Software (including any modifications or copies made by or for you) or any related intellectual property rights. Title and related rights in the content accessed through the Software is the property of the applicable content owner and may be protected by applicable law. This license gives you no rights to such contents. You hereby agree

1. Not to remove any copyright or other proprietary notices from the Software;
2. To reproduce all such notices on any authorized copies you make; and
3. To use best efforts to prevent any unauthorized copying of the Software.

TRADEMARKS

This Agreement does not grant to you any rights in connection with any trademarks or service marks of Acer or of Acer's licensors or suppliers.

DISCLAIMER OF WARRANTIES

TO THE MAXIMUM EXTENT PERMITTED BY APPLICABLE LAW, ACER, ITS SUPPLIERS, AND ITS LICENSORS, PROVIDE THE SOFTWARE "AS IS" AND WITH ALL FAULTS, AND HEREBY DISCLAIM ALL OTHER WARRANTIES AND CONDITIONS, EITHER EXPRESS, IMPLIED OR STATUTORY, INCLUDING, BUT NOT LIMITED TO, ANY IMPLIED WARRANTIES, DUTIES OR CONDITIONS OF MERCHANTABILITY, OF FITNESS FOR A PARTICULAR PURPOSE, OF ACCURACY OR COMPLETENESS OF RESPONSES, OF RESULTS, OF WORKMANLIKE EFFORT, OF LACK OF VIRUSES, AND OF LACK OF NEGLIGENCE, ALL WITH REGARD TO THE SOFTWARE AND THE PROVISION OF OR FAILURE TO PROVIDE SUPPORT SERVICES. ALSO, THERE IS NO WARRANTY OR CONDITION OF TITLE, QUIET ENJOYMENT, QUIET POSSESSION, CORRESPONDENCE TO DESCRIPTION OR NON-INFRINGEMENT WITH REGARD TO THE SOFTWARE.

EXCLUSION OF INCIDENTAL, CONSEQUENTIAL AND CERTAIN OTHER DAMAGES

TO THE MAXIMUM EXTENT PERMITTED BY APPLICABLE LAW, IN NO EVENT SHALL ACER, ACER'S SUPPLIERS, OR ACER'S LICENSORS, BE LIABLE FOR ANY SPECIAL, INCIDENTAL, INDIRECT, PUNITIVE, OR CONSEQUENTIAL DAMAGES WHATSOEVER (INCLUDING, BUT NOT LIMITED TO, DAMAGES FOR LOSS OF PROFITS OR CONFIDENTIAL OR OTHER INFORMATION, FOR BUSINESS INTERRUPTION, FOR PERSONAL INJURY, FOR LOSS OF PRIVACY, FOR FAILURE TO MEET ANY DUTY INCLUDING OF GOOD FAITH OR OF REASONABLE CARE, FOR NEGLIGENCE, AND FOR ANY OTHER PECUNIARY OR OTHER LOSS WHATSOEVER) ARISING OUT OF OR IN ANY WAY RELATED TO THE USE OF OR INABILITY TO USE THE SOFTWARE, THE PROVISION OF OR FAILURE TO PROVIDE SUPPORT SERVICES, OR OTHERWISE UNDER OR IN CONNECTION WITH ANY PROVISION OF THIS AGREEMENT, EVEN IN THE EVENT OF THE FAULT, TORT (INCLUDING NEGLIGENCE), STRICT LIABILITY, BREACH OF CONTRACT OR BREACH OF WARRANTY OF ACER OR ITS SUPPLIERS OR LICENSORS, AND EVEN IF ACER AND ITS SUPPLIERS AND LICENSORS HAVE BEEN ADVISED OF THE POSSIBILITY OF SUCH DAMAGES.

LIMITATION OF LIABILITY AND REMEDIES

NOTWITHSTANDING ANY DAMAGES THAT YOU MIGHT INCUR FOR ANY REASON WHATSOEVER (INCLUDING, WITHOUT LIMITATION, ALL DAMAGES REFERENCED ABOVE AND ALL DIRECT OR GENERAL DAMAGES), THE ENTIRE LIABILITY OF ACER, ITS SUPPLIERS, AND ITS LICENSORS, UNDER ANY PROVISION OF THIS AGREEMENT, AND YOUR EXCLUSIVE REMEDY FOR ALL OF THE FOREGOING, SHALL BE LIMITED TO THE AGGREGATE AMOUNT PAID BY YOU FOR THE SOFTWARE. THE FOREGOING LIMITATIONS, EXCLUSIONS AND DISCLAIMERS (INCLUDING DISCLAIMER OF WARRANTIES AND EXCLUSION OF INCIDENTAL, CONSEQUENTIAL AND CERTAIN OTHER DAMAGES ABOVE) SHALL APPLY TO THE MAXIMUM EXTENT PERMITTED BY APPLICABLE LAW, EVEN IF ANY REMEDY FAILS ITS ESSENTIAL PURPOSE; PROVIDED, HOWEVER, THAT BECAUSE SOME JURISDICTIONS DO NOT ALLOW THE EXCLUSION OR LIMITATION OR LIABILITY FOR CONSEQUENTIAL OR INCIDENTAL DAMAGES, THE ABOVE LIMITATION MAY NOT APPLY TO YOU.

TERMINATION

Without prejudice to any other rights, Acer may immediately terminate this Agreement without notice if you fail to comply with any terms and conditions of this Agreement.

In such event, you must:

1. Cease all use of the Software;
2. Destroy or return to Acer the original and all copies of the Software; and
3. Delete the Software from all phones on which it was resident.

All disclaimers of warranties and limitation of liability set forth in this Agreement shall survive termination of this Agreement.

GENERAL

This Agreement represents the complete agreement between you and Acer relating to this license for the Software and supersedes all prior agreements, communications, proposals and representations between the parties and prevails over any conflicting or additional terms of any quote, order, acknowledgement or similar communication. This Agreement may only be modified by a written document signed by both parties.

If any provision of this Agreement is held by a court of competent jurisdiction to be contrary to law that provision will be enforced to the maximum extent permissible and the remaining provisions of this Agreement will remain in full force and effect.

ADDITIONAL PROVISIONS APPLICABLE TO THIRD PARTY SOFTWARE AND SERVICES

Software provided hereunder by Acer's licensors or suppliers ("Third Party Software") is made available to you for your personal, non-commercial use only. You may not use the Third Party Software in any manner that could damage, disable, overburden, or impair the services provided by Acer's licensors or suppliers hereunder ("Third Party Services"). Furthermore, you may not use the Third Party Software in any manner that could interfere with any other party's use and enjoyment of the Third Party Services, or the services and products of Acer's licensors' or suppliers' third party licensors. Your use of the Third Party Software and Third Party Services is also subject to additional terms and conditions and policies which can be accessed through our global website.

Privacy policy

During registration you will be asked to submit some information to Acer. Please refer to Acer's privacy policy at <http://www.acer.com> or your local Acer website.

Table of Contents

End User Licence Agreement

Getting to know your smartphone

| | |
|------------------------------|---|
| Features and functions | 9 |
| Product registration | 9 |

Chapter 1: Setting Up

| | |
|--|----|
| Unpacking your smartphone | 11 |
| Getting to know your smartphone | 12 |
| Installing or removing the battery | 14 |
| Installing a SIM or microSD Card | 16 |
| Turning on for the first time | 17 |
| Using the touchscreen | 18 |
| The home screen | 19 |

Chapter 2: Making Calls

| | |
|-----------------------------|----|
| Before making a call | 23 |
| Making a call | 23 |
| The voice call screen | 25 |
| Onscreen call options | 25 |

Chapter 3: Messaging

| | |
|------------------------------|----|
| Creating a new message | 29 |
| Replying to a message | 30 |
| MMS messages | 31 |
| Setting up email | 33 |

Chapter 4: Using the Camera

| | |
|-----------------------------------|----|
| Camera icons and indicators | 35 |
| Taking a photo | 37 |
| Shooting a video | 37 |
| Viewing photos and videos | 38 |

Chapter 5: Advanced Settings

| | |
|--|----|
| Putting your smartphone in airplane mode | 39 |
| Acer Settings | 40 |
| Sound and display | 42 |
| Setting the date and time | 42 |
| Setting alarms | 43 |
| Changing location and text options | 43 |
| Managing your contacts | 44 |
| Managing your calendar | 46 |
| Connecting to a PC | 48 |
| Multimedia playback | 49 |
| FM radio | 50 |
| Managing applications | 51 |
| Resetting your smartphone | 52 |

Appendix

| | |
|--|----|
| FAQ and troubleshooting | 53 |
| Other sources of help | 54 |
| Specifications | 55 |
| Warnings and precautions | 57 |
| Emergency calls | 63 |
| Disposal and recycling information | 63 |
| Taking care of your smartphone | 65 |
| Safety regulations | 66 |

Getting to know your smartphone

Features and functions

Your new smartphone offers leading, easy-to-access multimedia and entertainment features. You can:

- Access your email while on the move.
- Connect to the Internet at high speed, via HSDPA (3.6 Mbps).
- Keep in touch with your friends via your Contacts and social networking applications.

Product registration

When using your product for the first time, it is recommended that you immediately register it. This will give you access to some useful benefits, such as:

- Faster service from our trained representatives
- Membership in the Acer community: receive promotions and participate in customer surveys
- The latest news from Acer

Hurry and register, as other advantages await you!

How to register

To register your Acer product, visit our website at **registration.acer.com**. Choose your country and follow the simple instructions.

You can also register directly from your smartphone by tapping the Acer Registration icon from the application tab.

After we receive your product registration, you will be sent a confirmation email with important data that you should keep in a safe place.

1. For detailed product information, please go to <http://mobile.acer.com/>
2. For service and support, please go to <http://www.acer.com/worldwide/support/download.htm>

Chapter 1: Setting Up

Unpacking your smartphone

Your new smartphone comes packed in a protective box. Carefully unpack the box and remove the contents. If any of the following items is missing or damaged, contact your dealer immediately:

- Acer beTouch E110 Smartphone
- Battery
- Quick Guide
- USB cable
- AC adapter
- Headset

Getting to know your smartphone

Views

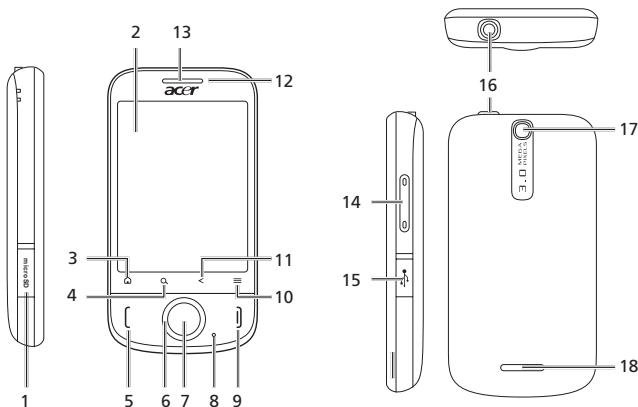

| No. | Item | Description |
|-----|-------------------|---|
| 1 | microSD Card slot | Expansion slot for microSD Card. |
| 2 | Touchscreen | 2.8-inch, 240 x 320 pixel resistive touchscreen to display data, phone content and enter information. |
| 3 | Home button | Return to the home screen. |
| 4 | Search button | Open the Telcel search function. |
| 5 | Call button | Activate phone/dial/view recently dialed numbers or answer a call. |
| 6 | Navigation pad | 4-way navigation control to move the cursor. |
| 7 | Selection button | Activates selected item. |

| No. | Item | Description |
|-----|-----------------------|--|
| 8 | Microphone | Internal microphone. |
| 9 | Power/End button | Press to turn the screen on/off or enter sleep mode; press and hold for more than three seconds to turn the smartphone off. Press to end a call. |
| 10 | Menu button | Opens the option menu. |
| 11 | Back button | Go back one menu step. |
| 12 | LED indicator | Indicates mail, message, missed call and battery status. |
| 13 | Phone speaker | Emits audio from your smartphone; suitable for holding to your ear. |
| 14 | Volume up/down button | Increase or decrease the phone volume. |
| 15 | Micro USB connector | Connects to a USB cable/charger. |
| 16 | 3.5 mm headphone jack | Connects to stereo headphones. |
| 17 | Camera | A 3-megapixel camera for taking high-resolution images. |
| 18 | Handsfree speaker | Emits audio from your smartphone; suitable for handsfree use. |

LED indicator

Mail, message, missed call and battery indicator:

| LED state | Description |
|-----------|---|
| Off | Battery charged; no unread mail or messages. |
| flashing | Low battery (less than 15%); missed call, unread mail or message. |
| On | Phone is charging. |

Installing or removing the battery

Your smartphone uses a replaceable battery to provide power. It is packed separately from your smartphone and needs to be inserted and charged before you can use the smartphone.

Installing the battery

Insert your fingernail into the cutout between the battery cover and the phone. Unclip the cover and lift off the battery cover.

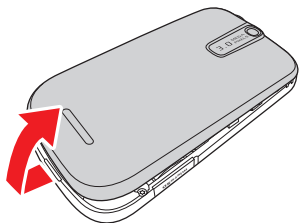

Place the battery into the battery compartment, lining up the battery connectors with those at the bottom of the compartment.

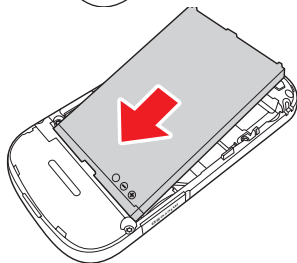

Insert the tabs on the top of the battery cover into the slots in the phone. Carefully press the top of the cover until the clips on the side of the cover click in place.

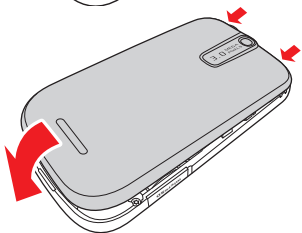



CAUTION: RISK OF EXPLOSION IF BATTERY IS REPLACED BY AN
INCORRECT TYPE.
DISPOSE OF USED BATTERIES ACCORDING TO THE INSTRUCTIONS.

Charging the battery

For initial use, you need to charge your smartphone for eight hours. After that you can charge it each day to recharge the battery to full capacity.

Connect the micro USB connector on your smartphone, then connect the USB connector to the AC adapter. Plug the AC adapter into any AC current outlet and charge the device.

It is normal for the phone to heat up when charging or during long periods of use. All phones are factory tested before release.

Removing the battery

Open the battery compartment as shown in **“Installing the battery” on page 14**. Lift the battery out of the compartment by grasping the sides of the battery.

Replace the battery cover as described above.

Installing a SIM or microSD Card

To take full advantage of your smartphone's telephony capabilities, you must install a SIM card. The SIM card holder is located in the battery bay.

Additionally, you may wish to increase your smartphone's storage by inserting a microSD Card into the slot provided. The slot is located on the left side of the phone.

1. Turn off the phone by pressing and holding the power button.
2. Open the cover and remove the battery as described in **"Removing the battery" on page 15.**
3. Insert the SIM or microSD Card as shown.

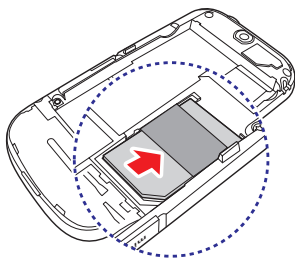

Note: The E110 can only be activated with a Telcel SIM card and does not support any other operators.

4. Replace the battery and battery cover.

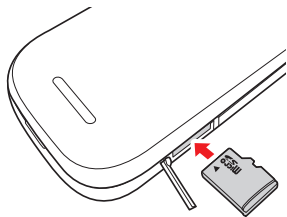



.....
Note: Ensure that the microSD Card is inserted all the way into the card slot.
.....

SIM card lock

Your smartphone may come with a SIM card lock, i.e., you will only be able to use the SIM card provided by your network operator.

To cancel the SIM lock, contact your network provider.

Turning on for the first time

To turn on your smartphone for the first time, press and hold the power button until the system bootup screen appears.

Calibrating the touchscreen

The first time you start the smartphone you will be required to calibrate the touchscreen. Follow the instructions shown on the screen and tap on the indicated crosshairs.

To recalibrate the touchscreen, open the applications tab and tap **Settings > Touch Calibration**.

Entering your PIN

When you install a SIM card for the first time, you may need to enter a PIN using the onscreen number pad.



.....
Important: Depending on your settings, you may be required to enter your PIN each time you switch on the phone function.
.....

If the PIN you enter is incorrect, a warning message appears.

Activating a new SIM card

If you are using your SIM card for the first time, it may require activation. Contact your network operator for details on how to do this.

Using the touchscreen

Your smartphone uses a touchscreen for selecting items and entering information. Use your finger to tap the screen.

Tap: Touch the screen once to open items and select options.

Drag: Hold your finger on the screen and drag across the screen to select text and images.

Tap and hold: Tap and hold an item to see a list of actions available for that item. On the pop-up menu that appears, tap the action you want to perform.

Scroll: To scroll up or down the screen, simply drag your finger up or down the screen in the direction that you want to scroll.

The onscreen keyboard

When you tap a text box to enter text, the onscreen keyboard will automatically display.



Text assistance

You can enable various features that assist you to enter correct text. Tap **Menu > Settings > Locale & Text > TouchPal**. From here you can enable or disable the following basic settings:

| Function | Description |
|-----------------|--|
| Word prediction | Inserts the suggested word whenever you tap space or a punctuation mark. |

| Function | Description |
|---------------------|---------------------------|
| Key press sound | Plays sound on key press. |
| Key press vibration | Vibrates on key press. |

The home screen

After rebooting, your smartphone will display the home screen. This screen gives you quick, icon-based access to many of the frequently-used features of your smartphone.

The first time you start your smartphone, you will see some icons on the screen.

At the bottom of the screen is the **Applications tab** which lists all the applications you have installed. Tap the tab to open the Applications tab. Tap an icon to open the application.

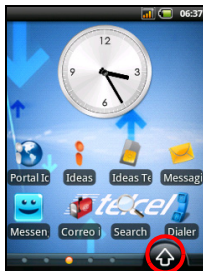

The extended home screen

The home screen extends to either side of the screen, giving you more room to add icons, widgets or features. To view the

extended home screen slide your finger to the left or right of the home screen.

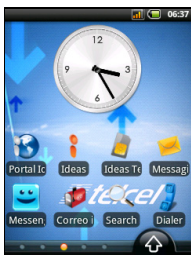
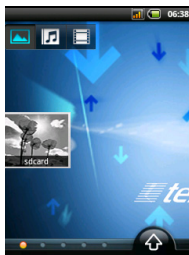

Personalizing the home screen

You may personalize your home screen by adding or removing icons, shortcuts or widgets, or changing the wallpaper.

Adding or removing icons

You can set icons for installed applications on the home screen. Tap and hold an icon in the Applications tab to copy it to the home screen. To remove an icon from the home screen, tap and hold the icon and drag the icon from the home screen to the trash tab that appears at the bottom of the screen.

Adding or removing shortcuts or widgets

To add shortcuts or widgets, tap and hold anywhere on the home screen to open the Add to Home screen menu. Tap **Shortcuts** to open a list of available shortcut types you can add.

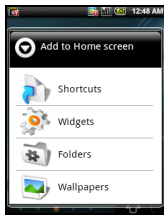

Widgets are handy applications that you can add to your home screen to display various information.





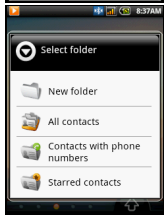









You can also add folders to your home screen. There are some pre-defined folders available or you can add a **New folder**. This will be placed on your home screen and named Folder.



Notification area

At the top of the screen is the Notification area. This contains a variety of icons to inform you of your phone's status. To the left of the Notification area are event icons that indicate a new event. The icons on the right of the screen indicate

connectivity status. Tap, hold and drag down the **Notification area** to view the new events.

| Icon | Description |
|---|---|
|  | Indicates the signal strength. |
|  | SD Card removed. |
|  | Bluetooth enabled. |
|  | Vibrate mode enabled. |
|  | SIM card not installed/invalid. |
|  | Battery status. |
|  | Missed call. |
|  | New/unread message. |
|  | Connected to the 3G data network. |
|  | Connected to the 2G data network. |
|  | Airplane mode: Wireless connectivity disconnected. Please disable airplane mode before trying to make a call. |
|  | Incoming call or active call. |

Chapter 2: Making Calls

This chapter shows you how to make phone calls, and the various options available to you during your call.

Before making a call

Check that the phone function is on before you make a call. You can confirm the phone status from the icon on the right-hand side of the Notification area.

| Icon | Description |
|------|-------------|
|------|-------------|



Connected: You may make a call.



Airplane mode: Wireless connectivity disconnected. Please disable airplane mode before trying to make a call.

Making a call

1. From the home screen tap **Dialer** or open **Dialer** from the Applications tab to open the onscreen number pad.
2. Enter the number you wish to dial.
3. Press the **Call** button to make the call.
4. To end the call, press the **End** button.

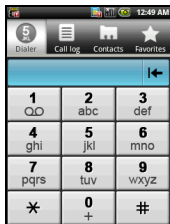

Note: The phone function needs to be enabled before the call can be connected.

Dialing a number from call log

Your call history can be viewed by tapping the **Call Log** tab. It displays recent received, dialed, and missed calls.

Tap a number to view the call details. To redial any number in the call history, select the number and tap **Return call**. You may also select **Send SMS/MMS** or **Add to contacts**.

Missed calls will be displayed by the call indicator on the top of your phone and in the Notification area with the icon .

You can also view missed calls from the Notification area.

1. Open the notification list by tapping and dragging the Notification area downwards to display the details of the missed calls.
2. Select the call from the list and tap **Return call** to return the missed call.

You can save phone numbers to your Contacts from the Call Log. Please refer to **"Adding a contact" on page 45** for further details.

Making a call to one of your contacts

1. Tap the **Contacts** tab in the dialer or **Contacts** from the home screen to view your contacts.
2. Tap a contact. A dialog will open, asking if you want to call the contact or send the contact a text message.

Dialing an international number

When dialing international numbers, there is no need to enter the international direct dialing prefix ('00' etc.) before the country code. Simply tap and hold **0+** on the onscreen number pad until **+** appears onscreen.



.....
Warning: International call rates can vary greatly depending on the country you are calling and your network provider. We suggest you check all call rates with your network provider, to avoid excessive phone bills. If you are using your smartphone abroad, roaming charges will apply. Consult your network provider for roaming rates specific to the country you are visiting before you leave.
.....

The voice call screen

Once you have dialed your number the voice call screen appears, which displays the number/contact you are talking to, the call duration and the dialpad tab.

Onscreen call options

Answering a call

Press the **Call** button to answer a call.

Rejecting a call

Press the **End** button to reject a call.

Ending a call

To end a call, press the **End** button.

Using the speakerphone

The speakerphone function allows you to take calls without having to hold your smartphone. This handsfree function is especially useful for multitasking.

To activate the speakerphone, tap **Menu** then tap **Speaker** on the voice call screen. Tap **Speaker** again to disable the speakerphone.

Muting a call

To mute a call, tap **Menu**, then tap **Mute** on the voice call screen to switch off the microphone. Tap **Mute** again to switch the microphone back on.

Saving a dialed or received call number to contacts

You can save a number you have dialed to your contacts for future use.

1. Select the number from the **Call log** tab, and tap **Add to contacts**.
2. Tap **Create new contact** and select how to complete the action. Please refer to **"Adding a contact"** on page 45.

Conference calls

If you have one or more calls on hold and another online, you can combine all calls to create a conference call.

After the first call is established, press the **Menu** button to bring up the dialog box. Tap **Add call** to add the second call. Tap **Merge calls** to start the conference call.

To end the conference call, tap **End call**.

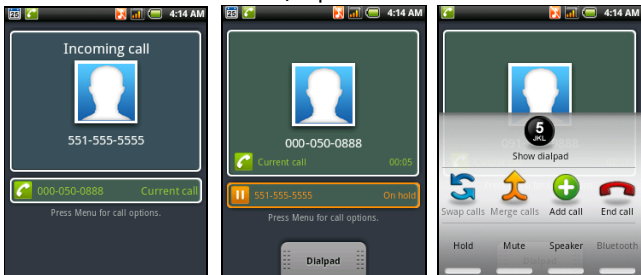

Chapter 3: Messaging

This chapter shows you how to set up and use the SMS and MMS functions of your smartphone.

All SMS and MMS messages are accessed via Messaging. Messaging automatically arranges received and sent messages into threads.

To access messaging, tap **Messaging** on the home screen.

Creating a new message

You can use your phone to compose SMS or MMS messages.

Tap **New message** to compose a new message.

Enter the recipient's phone number or name in the **To** field. Suggested contacts will be displayed in a drop-down list below the text field. To select a suggested contact, tap the contact's name.

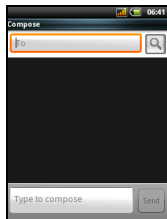









Once you have entered the recipient, enter your message in the text box labeled **Type to compose**.

You can use the navigation pad to move between fields and to close the onscreen keyboard.



.....
Note: SMS messages may be up to 160 characters long. If your message is longer than 160 characters, it will be sent as multiple linked messages. Most phones will automatically join the linked messages to present the recipient with a single long message, however, some older phones do not have this ability.
.....

Press the **Menu** button to see what options are available when creating a new message. The options change depending on the status of the message.







| Icon | Description |
|---|--|
|  | Convert the SMS to an MMS, allowing you to add a subject to the message. |
|  | View all the threads currently on your phone. |
|  | Convert the SMS to an MMS, allowing you to attach a file to the message. |
|  | Open the Dialer to call the recipient. |
|  | Discard the message. |
|  | Insert a smiley/emoticon into your message text. |
|  | Show other available options. |
|  | Send the message. |

Replying to a message

When a new text message arrives, a message icon appears in the Notification area.

Tap **Messaging** on the home screen to view the message list or expand the Notification area to see a summary of the message. Tap the summary to open the message list.

To reply to an SMS or MMS message, open the message from the message list. Enter your text in the text box labeled **Type to compose**. Press the **Menu** button to see available options.

| Icon | Description |
|---|--|
|  | Convert the SMS to an MMS, allowing you to add a subject to the message. |
|  | Convert the SMS to an MMS, allowing you to attach a file to the message. |
|  | Open the Dialer to call the recipient. |
|  | Delete the thread. |
|  | Insert a smiley/emoticon into your message text. |
|  | Show other available options. |
|  | Send the message. |

MMS messages

MMS messages are similar to text messages but also allow you to attach multimedia files such as pictures, audio or video clips. Each MMS message can be up to 1 MB in size.



Note: You need to set up an MMS profile before you can send MMS messages. Normally, your smartphone will set up the profile for you based on information retrieved from your provider.



Tip: Ask your network provider for the necessary information if you need to manually set up the MMS profile.

Receiving MMS messages

When a new MMS message arrives, a message icon appears at the top of the screen and a notification message is displayed.

1. Open Messaging to view a summary of the message.
2. Tap **Download** to download the message content.



Note: Downloads can take a long time, depending on your connection quality. If you reply or open another application, the download will be stopped.



Important: You may be charged to download message content, especially if you are roaming. Please contact your provider if you have any questions.

3. Tap the message to view the content.
4. Press the **Menu** button and tap **Reply** to reply to the message. The message window will appear. Simple text replies will be sent as SMS messages. If you wish to attach a file, press the Menu button and tap **Attach**. You will be presented with a list of options.
5. When you have finished composing the message, press the Menu button and tap **Send**.

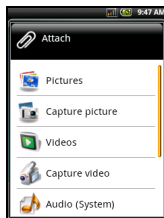

Setting up email

Your smartphone enables you to access your email. Most popular providers can be set up in two steps. Tap **Correo iTelcel** from the home screen or **Email** from the Applications tab to start setting up your email access.

1. Enter your email address and password for the account and then tap **Next**.
2. Enter the **Account name** and **Your name** and then tap **Done**.

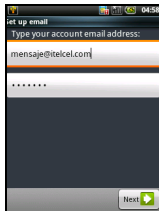

Composing an email

1. Tap **Email** from the home screen or Applications tab.
2. From the inbox, tap **Menu** and then tap **Compose**.
3. Enter the recipients email address, subject and message. You can use the navigation pad to move between fields and to close the onscreen keyboard.
4. When you are finished composing your message, tap **Send**.

Chapter 4: Using the Camera

Your smartphone features a 3-megapixel EDOF digital camera mounted on the rear. This section will take you through all the steps in taking photos and videos with your smartphone.



.....
Note: You need to have a microSD Card inserted into the microSD slot before you can use the camera.
.....

To activate the camera, open the Applications tab then tap **Camera**.

Camera icons and indicators



In the camera window, there are three icons on the screen to control certain features.

- Tap the yellow bar to adjust brightness.
- Use the zoom rocker at the bottom of the screen to adjust the zoom.

- Tap the camera icon to take a picture.
- To adjust the settings, press the Menu button and select **Settings**. The Settings options are:

| Settings | Description |
|----------------------------|---|
| Jpeg Quality | Set the JPG quality: <ul style="list-style-type: none">• Best• Better• Good |
| White Balance/ Lighting | Adjust the white balance: <ul style="list-style-type: none">• Automatic• Cloudy• Daylight• Fluorescent• Incandescent• Twilight |
| Color Effects | Apply an effect to the photo. Effects are: <ul style="list-style-type: none">• None: No effects are applied.• Negative: Uses negative colors.• Black/White: Uses black and white colors.• Sepia: Gives a brown/sepia tint.• Greenish: Gives a green tint.• Blueish: Gives a blue tint.• Redish: Gives a red tint. |
| Night Mode | Select between: <ul style="list-style-type: none">• Normal• Night |
| Resolution | Set the resolution to: <ul style="list-style-type: none">• 2048 x 1536• 1600 x 1200• 1280 x 1024• 640 x 480 Zoom is only available in 640 x 480. |
| Anti Banding | Set anti banding to: <ul style="list-style-type: none">• Auto• 50 Hz• 60 Hz |

| Settings | Description |
|------------------|--|
| Picture review | Set review time after picture capture: <ul style="list-style-type: none">• No preview• 3 seconds• 5 seconds• 10 seconds |
| Grid | Show grid in preview. |
| Shutter sound | Play shutter sound. |
| Prefix | Set default file name prefix. |
| Counter | Reset the counter back to 1. |
| Reset to default | Reset all settings to default values. |

Taking a photo

1. Ensure you have adjusted the parameters described above.
2. Frame your subject and steady your smartphone.
3. Zoom in or out as needed.
4. Tap the **Camera** icon or press the **Selection** button to take the photo.

Shooting a video

Turn on camcorder mode by tapping the video icon from the camera menu or by opening the Applications tab and tapping **Camcorder**.

1. Ensure you have adjusted the parameters described above.
2. Frame your subject and steady your smartphone.
3. Press the film button down to begin recording.
4. Press the film button down to stop recording.

Supported formats

The following file formats are supported:

| Type | Formats |
|-------|--------------------------------|
| Image | JPEG, BMP, PNG, GIF, DRM, WBMP |
| Video | 3GP, MPEG-4 |

Viewing photos and videos

After you have taken your photo or video, it is automatically saved.

Once you have taken a photo or video, you can view the it in Gallery by tapping **Gallery** in the menu. Alternatively, open the Applications tab and tap **Gallery**. From Gallery you can share the file directly via **MMS**.

Chapter 5: Advanced Settings

Putting your smartphone in airplane mode

You can enter airplane mode (also known as flight mode) to turn off telephone and Bluetooth and use your smartphone as a handheld device during a flight. Check with your airline to make sure this is permitted onboard.

Switch your smartphone off during takeoff and landing as it may interfere with aircraft electronic systems.

Turning airplane mode on or off

1. Tap the Applications tab, then tap **Settings > Wireless controls**.
2. Tap **Airplane mode** to switch it ON or OFF.



Note: When Airplane mode is active, the  icon will be displayed in the Notification area.

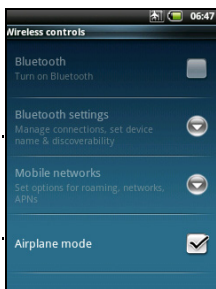

Acer Settings

Acer Settings is a convenient all-in-one place for you to adjust commonly-used settings on your phone. Open the Applications tab and tap **Acer Settings**.

From this screen you can turn Bluetooth on or off or adjust their settings by tapping .

You can also set your **Phone network settings**, set the screen **Brightness** or **Screen Timeout**.



Important: If your phone is in Airplane mode, the option to turn Bluetooth on will be disabled. Please refer to **“Putting your smartphone in airplane mode”** on page 39 for instructions on turning Airplane mode on or off.

Phone network settings

Tap **Phone network settings** to adjust your network settings. The following options will be available:

- Data enabled - Turn the data connection on or off.
- Data roaming - Connect to data services when roaming.
- Use only 2G networks - Restricts data connection to 2G networks and saves battery life.
- Network operator - Select a network operator.
- Access point names - Select APNs.

Please refer to **“Selecting a network”** for more information.

Selecting a network

Your phone will automatically detect your carrier/network settings when you insert a new SIM card. However, you may prefer to manually select a network. This may be a good idea when roaming.



.....
Tip: When you are traveling, manually selecting a network may help to reduce your roaming charges. Check with your home service provider for the network offering the most competitive rates at your destination.
.....

1. Open the Applications tab and tap **Settings > Wireless controls > Mobile networks > Network operators**.
2. Your phone will search for available networks.
3. Select your preferred network from the list generated. Your phone will attempt to register on the selected network.
4. Tap **Select automatically** to connect to the available network with the strongest signal. This may lead to your phone jumping between networks when you move around.



.....
Note: Contact your service provider should you have any problems obtaining voice mail and the text message service center numbers.
.....

Bluetooth connections

For all Bluetooth settings, open the Applications tab and tap **Settings > Wireless controls > Bluetooth settings**. Here you can switch Bluetooth on or off, set a device name and discoverability. Tap **Scan for devices** to scan for available devices.

To connect to a device, tap the device in the list of available devices. You may be asked to enter a PIN on both devices to establish the connection.

Sound and display

Adjust the volume of your phone using the volume button on the side of the phone. Alternatively, you can set the **Ringer volume** and **Media volume** by opening the Applications tab and going to **Settings > Sound & display**.

| Item | Description |
|-----------------------|---|
| Silent mode | Turn off all sounds except for alarms and media. |
| Ringer volume | Adjust the ringer volume. |
| Media volume | Set the playback volume for media. |
| Phone ringtone | Set your phone's ringtone. |
| Phone vibrate | Turn on vibration for incoming calls. |
| Notification ringtone | Set a ringtone for notifications. |
| Audible touch tones | Play tones when using dial pad. |
| Audible selection | Play a sound whenever a screen selection is made. |
| SD card notifications | Play a sound for SD card notifications. |
| Animation | Animate when opening or closing windows. |
| Brightness | Adjust screen brightness. |
| Screen timeout | Set idle time for screen timeout. |
| Notification LED | Turn on LED notification for calls and messages. |

Setting the date and time

Set the date and time by opening the Applications tab and going to **Settings > Date & time**.



Tip: If you travel frequently or live in an area that uses daylight saving time, activate **Automatic** from this menu. This will enable your smartphone to set the date and time based on information it receives from the network.

Setting alarms

There are three predefined alarms on your phone by default. To edit alarm settings, tap **Clock** in the Applications tab and tap on any of the predefined alarms. You may:

- Turn the alarm on or off.
- Set the alarm time.
- Set a ringtone.
- Enable or disable vibrate.
- Set which days to repeat the alarm.
- Give it a label.

To add a new alarm, tap **Menu**, then tap **Add alarm**.

To delete an alarm, tap an alarm, then tap **Menu > Delete**.

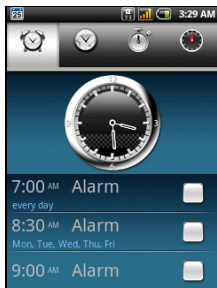

Changing location and text options

Set your location and language input preferences by opening the Applications tab and going to **Settings > Locale & text**.

Tap **Select Locale** to set the language you would like to use the phone in.

Tap **TouchPal** to set text input preferences. Under basic settings you may:

- Turn on word prediction.
- Turn on key press sound.
- Turn on key press vibration.
- Turn on mixed language input.
- Select Languages.





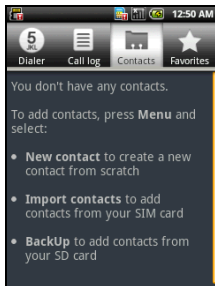

Managing your contacts

Your smartphone features an address book that allows you to save contacts to either the internal memory or onto your SIM card.

Tap **Contacts** from the home screen or the **Contacts** tab from the Dialer to view your contacts.

If you don't have any contacts stored on your phone, you can add a new contact or import any SIM contacts. Press the Menu button to open the menu.



| Icon | Description |
|---|--|
|  | Search for a contact. |
|  | Add a new contact. |
|  | Display the contacts you have assigned to a group. |
|  | Export to SD card. Import from SD card. |
|  | Import contacts from SIM. |
|  | Delete contacts from phone. |

Adding a contact

Tap **New contact** to add a new contact. You will be asked if you want to create a SIM contact or a Phone contact.

To create a contact, you will be asked to enter the contact's:

- First and Last name.
- Phone numbers.
- Email addresses.
- Postal addresses.

You may also:

- Enter information such as organizations the contact belongs to.
- Any personal notes about the contact.
- Set a ringtone.
- Send any calls from this contact directly to your voice-mail.

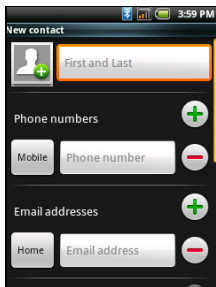

Importing / exporting SIM contacts

You may import all SIM contacts or export contacts to the SIM card.

1. Open **Contacts** from the home screen or from the Dialer.
2. Press the Menu button and tap **Import**. Tap a contact in the SIM to import to the phone, or press the Menu button and tap **Import all** to import all SIM contacts to the phone.

Deleting all phone contacts

You may delete all phone contacts at the same time.

1. Open **Contacts** from the home screen or from the Dialer.

2. Press the Menu button and tap **Delete > Delete all from phone.**

Managing your calendar

The Calendar allows you to keep track of your events and tasks. You can access it by tapping **Calendar** on the home screen or in the Applications tab.

The Calendar offers a variety of viewing modes and settings to manage your events. Tap **Menu** and you will see the following options:

- List
- Day
- Week
- Month
- New event
- New task
- Today
- Settings

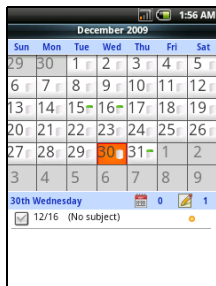

These additional options are under Settings:

- Lunar Calendar
- Festival
- Hide Declined Events
- Hide Completed Tasks
- Expand Event/Task in List
- Reminder Settings
- Import/Export
- Delete Settings

Adding a new event or task

To add a new event, tap Menu and tap **New event.**

To add a new task, tap Menu and tap **New task**.

Under Event details you have the option of filling out:

- Name
- From – Date and time
- To – Date and time
- Location
- Description
- Repetition
- Reminders

Under Task details you have the option of filling out:

- Name
- From – Date and time
- To – Date and time
- Description
- Priority
- Completion

Connecting to a PC

You can connect your phone to a PC using the supplied USB cable. Plug the USB sync cable into the micro USB connector on your smartphone. Plug the USB client connector into an available USB port on your computer.

Using mass storage

Open the Applications tab and tap **USB Mode Switcher**.

Once in USB Mode Switcher, select mass storage by sliding the ball to the right. Tap the red "STORAGE" text to activate mass storage.

Install the necessary drivers from PC Suite.

From your computer, download PC Suite from <http://www.acer.com.mx/>



Click **Servicio Técnico > Driver Download > Smart Handheld > beTouch Series > E110**

Select the latest version of PC Suite to download and follow the instructions during the installation.



Note: Additional help is available by swiping the screen from right to left.

Modem Sharing

Open the Applications tab and tap **USB Mode Switcher**.

Once in USB Mode Switcher, select modem sharing by sliding the ball to the right. Tap the red "MODEM" text to activate modem sharing.

Install the necessary drivers from PC Suite.



.....
Note: Additional help is available by swiping the screen from right to left.
.....

Browsing the Internet

In order to browse the Internet with your smartphone, you must be connected to a data network. Please see "**Phone network settings**" on page 40 for more information.

Tap **Browser** on the home screen to start browsing. To open a new website, tap **Menu** then tap **Go** to enter a URL.

Multimedia playback

Your smartphone comes supplied with a variety of programs that you can use to enjoy multimedia content.

nemoPlayer

Open **nemoPlayer** from the Applications tab to play media you have stored on your phone.

nemoPlayer enables you to listen to music, view video clips and pictures in the following formats.

| Type | Formats |
|-----------------|--------------------------------|
| Audio playback | MP3, AAC, AMR |
| Ringtone | MP3, MIDI, iMelody, WAVE |
| Video recording | 3GP, MPEG-4, H.263 |
| Video playback | 3GP, MPEG-4, H.263, H.264, WMV |

FM radio

The FM radio allows you to listen to your favorite stations while on the move. Headphones must be inserted to the 3.5 mm jack as it functions as an antenna.

You can access the radio by tapping **Radio** from the Applications tab. Once the application is open, turn the radio on by tapping **Menu** and **Turn on**. You can now leave the radio application and use other functions of the smartphone and listen to your station.

To turn the radio off, return to the radio application and tap **Menu** and **Turn off**.

Other functions are available through the Menu such as:

- Mute
- Set frequency
- Scan
- Save
- Speaker on
- RDS on



- Station list
- Send station info

Managing applications



.....
Warning! Make sure you trust the source of any program you install. If you are not sure of the source, do not install a program. Installing programs from unknown sources increases your risk of virus attacks and theft of personal and private data.
.....

You can remove programs installed on your smartphone to free up extra storage memory. Open the Applications tab and going to **Settings > Applications**.

Here you can allow programs from **Unknown sources** to be installed and **Manage Applications**.



.....
Warning! You should only remove programs if you are familiar with the Android operating system.
.....

Resetting your smartphone

You may have to perform a reset if your smartphone fails to respond when buttons are pressed or the screen is tapped.



.....
Note: Before performing a reset, ensure that your smartphone is not locked. Press any key or tap the screen to see if the phone responds.
.....

Clean boot



.....
Warning! You should only perform a clean boot when all other options have failed to restore your smartphone to an operational state.
.....

A clean boot will restore your smartphone to the factory settings.



.....
Warning! This will erase all your personal information, any contacts stored on your phone and any programs you installed.
.....

1. Open the Applications tab and go to **Settings > SD card & Phone storage > Factory data reset.**
2. On the Factory data reset screen, tap **Reset Phone** and then tap **Erase everything.**

Appendix

FAQ and troubleshooting

This section lists frequently asked questions that may arise during the use of your smartphone, and gives easy answers and solutions to these questions.

| Aspect | Question | Answer |
|------------------------------------|---|--|
| Audio | Why is there no sound coming from the device? | If the headset is plugged into the device, the speaker is automatically shut off. Disconnect the headset. Check that the device volume setting is not muted. Check that the volume control is not at its lowest setting. |
| Multimedia files | Why can't I view my picture files? | You may be trying to view an image that is not supported. Refer to "Multimedia" on page 55 for more information. |
| | Why can't I view my video files? | You may be trying to view a video that is not supported. Refer to "Multimedia" on page 55 for more information. |
| | Why can't I play my music files? | You may be trying to play a file that is not supported. Refer to "Multimedia" on page 55 for more information. |
| System information and performance | How do I check the OS version of my device? | Tap Menu > Settings > About phone to check the OS version (Kernel/build number) and other hardware and software information. |

| Aspect | Question | Answer |
|--------|---|---|
| Power | I couldn't turn on the device. | The battery power may be depleted. Recharge the device. Refer to "Charging the battery" on page 15 for more information. |
| Heat | The phone heats up when charging or making long duration calls. | <p>It is normal for the phone to heat up when charging. When charging is complete, it will return to its normal temperature.</p> <p>It is also normal for the phone to heat up during long periods of use, such as watching a video or a long phone conversation.</p> <p>All Acer phones are factory tested before release.</p> |

Other sources of help

For information on:

For detailed product information

<http://mobile.acer.com/>

For service and support

<http://www.acer.com/worldwide/support/download.htm>

Specifications

Performance

- STE PNX6715, 416 MHz
- System memory:
 - 256 MB of SDRAM
 - 256 MB of Flash ROM
- Google Android operating system

Display

- 2.8" QVGA TFT, Resistive Touch Panel
- 320 x 240 resolution
- 65K colors support

Multimedia

- CD-quality stereo output
- Mono speaker 0.5 W (max)
- Omni-directional microphone
- Formats supported

| Type | Formats |
|-----------------|-------------------------------|
| Audio playback | MP3, AAC, AMR |
| Ringtone | MP3, MIDI, DLS, iMelody, WAVE |
| Video recording | 3GP, MPEG-4, H.263 |
| Video playback | 3GP, MPEG-4, H.263, H.264 |

USB connector

- 10-pin micro USB connector
- USB Client
- DC power-in (5 V, 1 A)

Connectivity

- Bluetooth 2.0+EDR
- GSM 850 / 900 / 1800 / 1900
- UMTS 850 / 1900
- HSDPA / EDGE / GPRS

Camera

- 3-megapixel EDOF

Expansion

- microSD memory card (up to 32 GB)

Battery

- Rechargeable 1500 mAh Lithium-ion battery (replaceable)



.....
Note: Length of battery operation will depend on power consumption which is based on system resource use. For example, constantly using the backlight or using power-demanding Applications will shorten battery life between charges.
.....

AC adapter

- AC input voltage: 100~240 Vac, 50/60 Hz
- AC input current: 0.3 Aac
- DC output voltage: 5 Vdc
- DC output current: 1A Max

Dimensions

| | |
|-----------|-----------------------|
| Height | 103.5 mm |
| Width | 54 mm |
| Thickness | 13.4 mm |
| Weight | <105 g (with battery) |

Warnings and precautions

- Do not use this product near water.
- Do not place this product on an unstable cart, stand or table. If the product falls, it could be seriously damaged.
- Never push objects of any kind into this product through slots as they may touch dangerous voltage points or short-out parts that could result in a fire or electric shock. Never spill liquid of any kind onto or into the product.
- To avoid damage of internal components and to prevent battery leakage, do not place the product on a vibrating surface.
- Never use this product when engaging in sporting activities, exercising, or in any vibrating environment which may cause a short circuit or damage, and even a risk of explosion from the battery pack.

CAUTION when listening to music

To protect your hearing, follow these instructions.

- Increase the volume gradually until you can hear clearly and comfortably.
- Do not increase the volume level after your ears have adjusted.

- Do not listen to music at high volumes for extended periods.
- Do not increase the volume to block out noisy surroundings.
- Decrease the volume if you can't hear people speaking near you.

Battery information

This product uses a Lithium-ion battery. Do not use it in a humid, wet and/or corrosive environment. Do not put, store or leave your product in or near a heat source, in a high temperature location, in strong direct sunlight, in a microwave oven or in a pressurized container, and do not expose it to temperatures over 60 °C (140 °F). Failure to follow these guidelines may cause the battery to leak acid, become hot, explode or ignite and cause injury and/or damage. Do not pierce, open or disassemble the battery. If the battery leaks and you come into contact with the leaked fluids, rinse thoroughly with water and seek medical attention immediately. For safety reasons, and to prolong the lifetime of the battery, charging will not occur at low (below 0 °C/32 °F) or high (over 40 °C/104 °F) temperatures.

The full performance of a new battery is achieved only after two or three complete charge and discharge cycles. The battery can be charged and discharged hundreds of times, but it will eventually wear out. When the talk and standby times are noticeably shorter than normal, buy a new battery. Use only Acer approved batteries, and recharge your battery only with Acer approved chargers designated for this device.

Unplug the charger from the electrical plug and the device when not in use. Do not leave a fully charged battery connected to the ac charger, since overcharging may shorten its lifetime. If left unused, a fully charged battery will lose its charge over time. If the battery is completely discharged, it

may take a few minutes before the charging indicator appears on the display or before any calls can be made.

Use the battery only for its intended purpose. Never use any charger or battery that is damaged.

Do not short-circuit the battery. Accidental short-circuiting can occur when a metallic object such as a coin, clip, or pen causes direct connection of the positive (+) and negative (-) terminals of the battery. (These look like metal strips on the battery.)

This might happen, for example, when you carry a spare battery in your pocket or purse. Short-circuiting the terminals may damage the battery or the connecting object.

Leaving the battery in hot or cold places, such as in a closed car in summer or winter conditions, will reduce the capacity and lifetime of the battery. Always try to keep the battery between 15 °C and 25 °C (59 °F and 77 °F). A device with a hot or cold battery may not work temporarily, even when the battery is fully charged. Battery performance is particularly limited in temperatures well below freezing.

Do not dispose of batteries in a fire as they may explode. Batteries may also explode if damaged. Dispose of batteries according to local regulations. Please recycle when possible. Do not dispose as household waste.

Replacing the battery pack

Your smartphone uses lithium batteries. Replace the battery with the same type as that which came bundled with your product. Use of another battery may present a risk of fire or explosion.



.....
Warning! Batteries may explode if not handled properly. Do not disassemble or dispose of them in fire. Keep them away from children. Follow local regulations when disposing of used batteries.
.....

Additional safety information

Your device and its enhancements may contain small parts. Keep them out of the reach of small children.

Operating environment



.....
Warning! For safety reasons, turn off all wireless or radio transmitting devices when using your smartphone device under the following conditions. These devices may include, but are not limited to: Bluetooth and/or 3G.
.....

Remember to follow any special regulations in force in any area, and always switch off your device when its use is prohibited or when it may cause interference or danger. Use the device only in its normal operating positions. Do not cover the antenna with metal and you should position the device at the above-stated distance from your body. To successfully transmit data files or messages, this device requires a good quality connection to the network. In some cases, transmission of data files or messages may be delayed until such a connection is available. Parts of the device are magnetic. Metallic materials may be attracted to the device, and persons with hearing aids should not hold the device to the ear with the hearing aid. Do not place credit cards or other magnetic storage media near the device, because information stored on them may be erased.

Medical devices

Operation of any radio transmitting equipment, including wireless phones, may interfere with the functionality of inadequately protected medical devices. Consult a physician or the manufacturer of the medical device to determine if they are adequately shielded from external RF energy or if you have any questions. Switch off your device in health care facilities

when any regulations posted in these areas instruct you to do so. Hospitals or health care facilities may be using equipment that could be sensitive to external RF transmissions.

Pacemakers. Pacemaker manufacturers recommend that a minimum separation of 15.3 cm (6") be maintained between wireless devices and a pacemaker to avoid potential interference with the pacemaker. These recommendations are consistent with the independent research by and recommendations of Wireless Technology Research. Persons with pacemakers should do the following:

- Always keep the device more than 15.3 cm (6") from the pacemaker.
- Not carry the device near your pacemaker when the device is switched on. If you suspect interference, switch off your device, and move it.

Hearing aids. Some digital wireless devices may interfere with some hearing aids. If interference occurs, consult your service provider.

Vehicles

RF signals may affect improperly installed or inadequately shielded electronic systems in motor vehicles such as electronic fuel injection systems, electronic antiskid (antilock) braking systems, electronic speed control systems, and air bag systems. For more information, check with the manufacturer, or its representative, of your vehicle or any equipment that has been added. Only qualified personnel should service the device, or install the device in a vehicle. Faulty installation or service may be dangerous and may invalidate any warranty that may apply to the device. Check regularly that all wireless equipment in your vehicle is mounted and operating properly. Do not store or carry flammable liquids, gases, or explosive materials in the same compartment as the device, its parts, or enhancements. For vehicles equipped with an air bag, remember that air bags

inflate with great force. Do not place objects, including installed or portable wireless equipment in the area over the air bag or in the air bag deployment area. If in-vehicle wireless equipment is improperly installed, and the air bag inflates, serious injury could result. Using your device while flying in aircraft is prohibited. Switch off your device before boarding an aircraft. The use of wireless teledevices in an aircraft may be dangerous to the operation of the aircraft, disrupt the wireless telephone network, and may be illegal.

Potentially explosive environments

Switch off your device when in any area with a potentially explosive atmosphere and obey all signs and instructions. Potentially explosive atmospheres include areas where you would normally be advised to turn off your vehicle engine. Sparks in such areas could cause an explosion or fire resulting in bodily injury or even death. Switch off the device at refueling points such as near gas pumps at service stations. Observe restrictions on the use of radio equipment in fuel depots, storage, and distribution areas; chemical plants; or where blasting operations are in progress. Areas with a potentially explosive atmospheres are often, but not always, clearly marked. They include below deck on boats, chemical transfer or storage facilities, vehicles using liquefied petroleum gas (such as propane or butane), and areas where the air contains chemicals or particles such as grain, dust or metal powders.

Follow any restrictions. Do not use the device where blasting is in progress.

Emergency calls

Important: Wireless phones, including this device, operate using radio signals, wireless networks, landline networks, and user-programmed functions. Because of this, connections in all conditions cannot be guaranteed. You should never rely solely on any wireless device for essential communications like medical emergencies.

If certain features are in use, you may first need to turn those features off before you can make an emergency call. Consult this guide or your service provider for more information.

When making an emergency call, give all the necessary information as accurately as possible. Your wireless device may be the only means of communication at the scene of an accident. Do not end the call until given permission to do so.

Disposal and recycling information

Do not throw this electronic device into the trash when discarding.

To minimize pollution and ensure utmost protection of the global environment, please recycle. For more information on the Waste from Electrical and Electronics Equipment (WEEE) regulations, visit

www.acer-group.com/public/Sustainability/sustainability01.htm



RoHS compliance

This product is in compliance with Directive 2002/95/EC of the European Parliament and of the Council of 27 January 2003, on the restriction of the use of certain hazardous substances in electrical and electronic equipment (RoHS) and its amendments.

Mercury advisory

For projectors or electronic products containing an LCD/CRT monitor or display:

Lamp(s) inside this product contain mercury and must be recycled or disposed of according to local, state or federal laws. For more information, contact the Electronic Industries Alliance at www.eiae.org. For lamp-specific disposal information, check www.lamprecycle.org.



Taking care of your smartphone

1. **DO** take care not to scratch the screen of your smartphone. Keep the screen clean. When working with your smartphone, use your finger or fingernail. Never use an actual pen or pencil or other sharp object on the screen surface.
2. **DO NOT** expose your smartphone to rain or moisture. Do not let water enter the circuitry through the front panel buttons or expansion slots. In general, treat your smartphone as you would a mobile phone or other small electronic device.
3. **DO** be careful not to drop your smartphone or subject it to any strong impact. Do not place your smartphone in your back pocket.
4. **DO NOT** expose your smartphone to extreme temperatures. For example, do not leave your smartphone on the dashboard of a car on a hot day or when temperatures are below freezing point. Also, keep it away from heaters and other sources of heat.
5. **DO NOT** use or store your smartphone in any location that is dusty, damp or wet.
6. **DO** use a soft, damp cloth to clean your smartphone. If the surface of the screen becomes soiled, clean it with a soft cloth moistened with diluted window-cleaning solution.
7. **DO NOT** press down on the screen with force, otherwise you may crack the screen.

Safety regulations

Regulatory information

Compliant with Russian regulatory certification.



LCD pixel statement

The LCD unit is produced with high-precision manufacturing techniques. Nevertheless, some pixels may occasionally misfire or appear as black or red dots. This has no effect on the recorded image and does not constitute a malfunction.

List of National Codes

This equipment may be operated in the following countries:

| Country | ISO 3166 2 letter code | Country | ISO 3166 2 letter code |
|----------------|---------------------------|----------------|---------------------------|
| Austria | AT | Malta | MT |
| Belgium | BE | Netherlands | NT |
| Cyprus | CY | Poland | PL |
| Czech Republic | CZ | Portugal | PT |
| Denmark | DK | Slovakia | SK |
| Estonia | EE | Slovenia | SL |
| Finland | FI | Spain | ES |
| France | FR | Sweden | SE |
| Germany | DE | United Kingdom | GB |
| Greece | GR | Iceland | IS |
| Hungary | HU | Liechtenstein | LI |
| Ireland | IE | Norway | NO |
| Italy | IT | Switzerland | CH |
| Latvia | LV | Bulgaria | BG |
| Lithuania | LT | Romania | RO |
| Luxembourg | LU | Turkey | TR |

FCC regulations

This mobile phone complies with part 15 of the FCC Rules. Operation is subject to the following two conditions: (1) This device may not cause harmful interference, and (2) this device must accept any interference received, including interference that may cause undesired operation.

This mobile phone has been tested and found to comply with the limits for a Class B digital device, pursuant to Part 15 of the FCC Rules. These limits are designed to provide reasonable protection against harmful interference in a residential installation. This equipment generates, uses and can radiated radio frequency energy and, if not installed and used in accordance with the instructions, may cause harmful interference to radio communications. However, there is no guarantee that interference will not occur in a particular installation. If this equipment does cause harmful interference to radio or television reception, which can be determined by turning the equipment off and on, the user is encouraged to try to correct the interference by one or more of the following measures:

- Reorient or relocate the receiving antenna.
- Increase the separation between the equipment and receiver.
- Connect the equipment into an outlet on a circuit different from that to which the receiver is connected.
- Consult the dealer or an experienced radio/TV technician for help.

Changes or modifications not expressly approved by the party responsible for compliance could void the user's authority to operate the equipment.

The antenna(s) used for this transmitter must not be co-located or operating in conjunction with any other antenna or transmitter.

RF exposure information (SAR)

This mobile phone meets the government's requirements for exposure to radio waves.

This phone is designed and manufactured not to exceed the emission limits for exposure to radio frequency (RF) energy set by the Federal Communications Commission of the U.S. Government.

The exposure standard for wireless mobile phones employs a unit of measurement known as the Specific Absorption Rate, or SAR. The SAR limit set by the FCC is 1.6W/kg.

Tests for SAR are conducted using standard operating positions accepted by the FCC with the phone transmitting at its highest certified power level in all tested frequency bands. Although the SAR is determined at the highest certified power level, the actual SAR level of the phone while operating can be well below the maximum value. This is because the phone is designed to operate at multiple power levels so as to use only the power required to reach the network. In general, the closer you are to a wireless base station antenna, the lower the power output.

The highest SAR value for the model phone as reported to the FCC when tested for use at the ear is 1.09 W/kg and when worn on the body, as described in this user guide, is 0.662 W/kg.



.....
Important: Body-worn measurements differ among phone models, depending upon available enhancements and FCC requirements.
.....

While there may be differences between the SAR levels of various phones and at various positions, they all meet the government requirements.

The FCC has granted an Equipment Authorization for this model phone with all reported SAR levels evaluated as in compliance with the FCC RF exposure guidelines. SAR information on this model phone is on file with the FCC and can be found under the Display Grant section of www.fcc.gov/oet/ea/fccid after searching on **FCC ID: HLZDME110**.

For body worn operation, this phone has been tested and meets the FCC RF exposure guidelines for use with accessories that contain no metal and that position the handset a minimum of 1.5 cm from the body. Use of other accessories may not ensure compliance with FCC RF exposure guidelines. If you do not use a body-worn accessory and are not holding the phone at the ear, position the handset a minimum of 1.5 cm from your body when the phone is switched on.

Lithium-ion battery warning



Caution! Danger of explosion if battery is incorrectly replaced. Replace only with the same or equivalent type recommended by the manufacturer. Dispose of used batteries according to the manufacturer's instructions.



¡ATENCIÓN! Riesgo de explosión si la pila no se cambia correctamente. Sustitúyala únicamente por el mismo tipo de pila o por un tipo equivalente recomendado por el fabricante. Elimine las pilas ya utilizadas de acuerdo con las instrucciones del fabricante.



Atenção! Perigo de explosão se a bateria for colocada incorrectamente. Colocar apenas o mesmo tipo ou tipo equivalente, recomendado pelo fabricante. Deite fora baterias usadas de acordo com as instruções do fabricante.

| | | | | |
|---------------------------------|----------|--|------------------------------|----------|
| | B | | | I |
| battery | | | international numbers | 24 |
| charging | 15 | | L | |
| information | 56 | | LED indicators | 13 |
| Browsing the internet | 49 | | M | |
| | C | | Managing your calendar | 46 |
| call history | 24 | | MMS messages | 31 |
| calls | | | Modem sharing | 49 |
| answering | 25 | | O | |
| ending | 25 | | onscreen keyboard | 18 |
| onscreen options | 25 | | P | |
| camera | | | performance | 55 |
| icons and indicators | 35 | | phone | |
| information | 56 | | connections | 41 |
| shooting a video | 37 | | S | |
| supported formats | 38 | | safety regulations | 57 |
| taking a photo | 37 | | Setting alarms | 43 |
| conference calls | 27 | | speakerphone | 25 |
| connectivity | 56 | | specifications | 54 |
| contacts | | | T | |
| adding and editing | 45 | | troubleshooting | 53 |
| making calls to a contact | 24 | | turning on | 17 |
| | D | | U | |
| display | 55 | | USB connector | 55 |
| | E | | V | |
| email | 33 | | views | |
| | F | | left | 13 |
| FAQs | 53 | | voice calls | |
| FM radio | 50 | | the voice call screen | 25 |
| | H | | | |
| help | | | | |
| sources | 54 | | | |

